

– weishaupt –

product

Information on compact burners



Digital combustion technology

Weishaupt gas burners, WG 10 to WG 40 (12.5 – 550 kW)

Hot for quality

Our motivation is technological progress, which has been driving us for more than 50 years to set new standards for the combustion industry.

Weishaupt's own Research and Development Centre is constantly working on both new developments and the optimisation of existing products.

It is our goal and our responsibility to go above and beyond current legislative requirements in developing combustion systems which produce fewer and fewer emissions, save more and more energy, and in so doing combine ecology and economy in a practical manner.

Therefore, not only do we invest in research and technology but we also only ever work on the best materials with modern tools and we carry out meticulous quality control checks.

It has been proven over a million times in the field that heating specialists and customers hold Weishaupt burners to be reliable, long lasting, environmentally friendly and technologically advanced. A fact also documented by numerous design and innovation prizes.

Over 600 burners are manufactured daily at our ultra-modern production facilities in Schwendi. Every single burner is subjected to a mechanical and electrical function test. The combination of technology with an effective quality control system safeguards Weishaupt's renowned reputation for quality.

A new burner is always an investment in the future. Cost needs to be well balanced against use, but the final deciding factors for long term success are quality, technology and safety. Deciding for Weishaupt burners is therefore a safe investment in the future.



Ultra-modern research and production methods and rigorous quality control ensures the quality for which Weishaupt is renowned

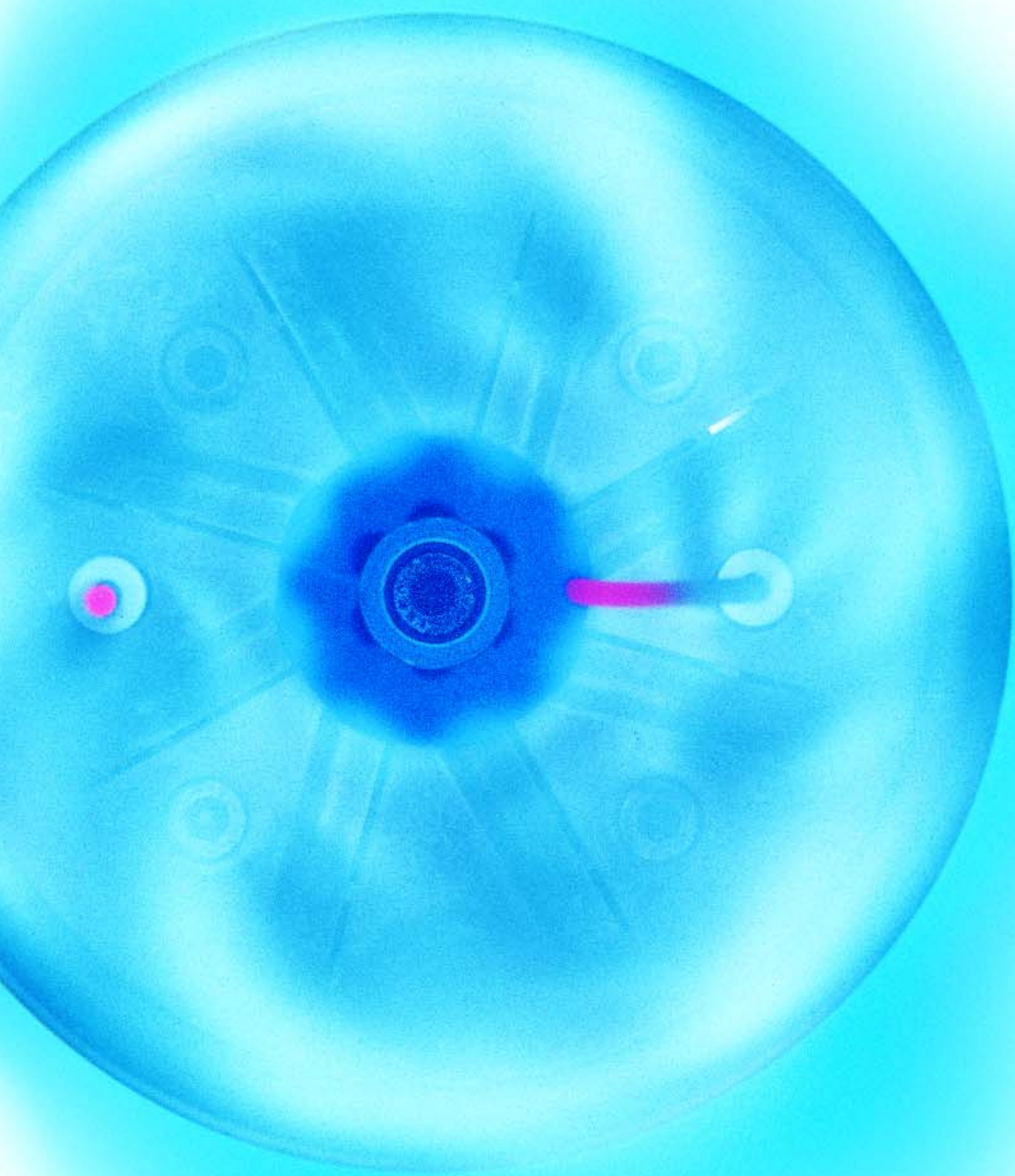



A hallmark of practical combustion technology

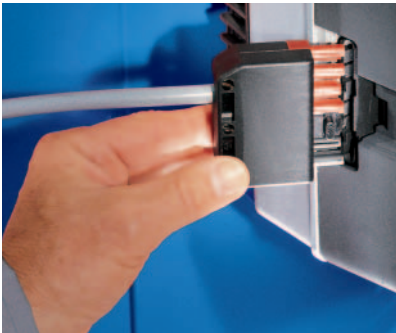

Coded plugs for safe electrical connection



All components are easily accessible



Simple commissioning and diagnosis

A safe investment in the future

Reliable and economical: The millionfold success of the Weishaupt compact burners is the result of orienting without compromise towards quality and the customer. The technology has been constantly developed and improved over decades.

The latest production methods and stringent quality checks of all products ensure Weishaupt's reputation for quality. You are making a safe investment in the future.

Large capacity range

The large capacity range of 12.5 to 550 kW makes the burners suitable for the widest range of heat exchangers.

Electronic ignition

The W-ZG 01 ignition unit used on all Weishaupt W burners is particularly energy efficient and extremely reliable.

Digital combustion management for safety and ease of use

Weishaupt is a pioneer in this field. Digital combustion management offers greater ease of use and simple servicing, even greater reliability in operation, and, last but not least, an extremely attractive price/capacity relationship. Furthermore, this intelligent technology enables the burner to be integrated with complex automation systems.

Valve proving as standard with W-FM10 and W-FM20 combustion managers

The low gas pressure switch is used to check the tightness of the gas valves, thus providing valve proving without the need for any additional components or costs.

Gas multifunction assembly

The newly conceived gas multifunction assembly incorporates the following components/functions:

- Servo-controlled gas pressure governor for continual gas pressure
- 2 solenoid valves (Class A)
- Filter
- Gas pressure switch

If the gas pressure falls too low, a low gas pressure program is started. The gas pressure switch also provides for automatic valve proving.

Outstanding service

Weishaupt has an extensive sales and service network worldwide. Customer service is available around the clock. Optimal in-house training at Weishaupt ensures our service engineers are of the highest calibre.

Proven quality

All burners are tested by an independent body and conform to the following standards and EU directives:

- EN 676
- Gas Appliance Directive 90/396/EEC
- Machinery Directive 98/37/EC
- Electromagnetic Compatibility Directive 89/336/EEC
- Low Voltage Directive 73/23/EEC
- Boiler Efficiency Directive 92/42/EEC

WG30 and WG40 also conform to:

- Pressure Equipment Directive 97/23/EC

The right size Weishaupt burner for every situation

Digital combustion management: safe and easy to use



All Weishaupt W series burners are fitted with digital combustion managers as standard, whose microprocessors control and monitor all burner functions. The result: Weishaupt burners are easy to use, precise and safe.

The digital combustion managers also offer the possibility of communicating with other systems via an integrated eBUS port. This enables the heating engineer to monitor the operation of the burner and remotely diagnose any errors.

The key points:

- The utilisation of identical units for gas and oil burners simplifies commissioning and reduces the number of spares required.
- Non-interchangeable plug connections ensure the correct electrical connection of all components
- Electrical remote reset is possible
- Safety ensured with the use of two microprocessors (reciprocal monitoring)
- Vari-coloured LED lamp to indicate burner operational stage and fault conditions (WG 10, WG20 versions LN and Z-LN)
- LCD display with interrogation, servicing and parameter functions. the burner can be set directly via the operating keys (WG 10 – WG40 version ZM-LN)
- Suitable for continuous operation of hot water plant (controlled shutdown and restart every 24 hours)
- Suitable for air heaters and Group II, III, and IV steam boilers (W-FM 21 optional)
- The integrated eBUS interface offers the following functions:
 - Connection to a PC for display of the operational sequence and the setting of function parameters
 - Remote monitoring and diagnosis via a self dialling modem
 - Connection to modern building management systems
 - Prepurge time can be set from a PC via the eBUS interface

System overview		W-FM 05	W-FM 10	W-FM 20	W-FM 21
Digital combustion management					
Combustion manager for intermittent operation		●	●	●	●
Combustion manager for continuous operation					●
Flame sensor		lon	lon	lon	lon
Electronic compound regulation	Air and gas			●	●
Stepping motor	Air		●		
Removable control unit (max. distance)				10 m	10 m
Valve proving			●	●	●
Fuel consumption meter available			●	●	●
eBUS interface		●	●	●	●
Available on burner models		WG 10-D WG 20-C single stage without servomotor	WG 10-D WG 20-C single stage with servomotor and two stage	WG 10 – WG 40 modulating WG 30 – WG 40 with speed control	WG 10 – WG 40 modulating WG 30 – WG 40 with speed control TRD execution

The right mode of operation for every heating need

Gas burners
Single and two stage
 With mechanical compound regulation and integral gas valve proving

W-FM 10 combustion manager

Gas butterfly valve

Gas multifunction assembly

Air stepping motor (with linkage to gas butterfly valve)

Gas burners
Sliding two stage / modulating
 With electronic compound regulation and integral gas valve proving

W-FM 20 combustion manager

Gas stepping motor

Gas multifunction assembly

Air stepping motor

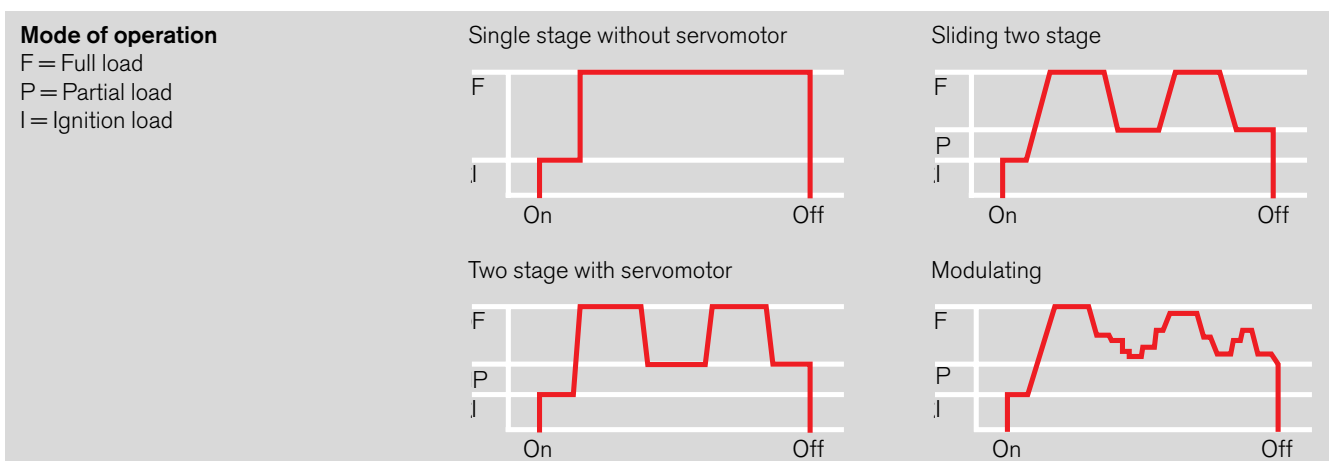

Trustworthy technology

Even the visual impression after removing the burner cover is convincing. All components are clearly arranged, the electrical connections are obvious and non-interchangeable. The technology makes a good impression because it is typical Weishaupt.

Compact construction

The WG burners' compact construction means they can be easily installed by one person. Commissioning costs have been reduced to a minimum.

Low NO_x execution

All WG burners are Low NO_x execution as standard. A specially designed mixing head produces an intensive internal flue gas recirculation, resulting in exemplary emission levels.

Sound attenuated air inlet

The transverse fan is sound attenuated on the suction side. These burners therefore operate particularly quietly.

Electronically controlled air damper

The electronically controlled air damper closes at burner shutdown to hinder the cooling-down of the combustion chamber.

Sevicing position

A special bracket enables the burner to be put into a servicing position, which enabling easy access to the burner and mixing assembly.

Common platform

The common platform principle used with W burners simplifies the provision and storage of spare parts.

Diagnosis via laptop

A special software package and connection cables are available for interrogating the combustion manager. Combustion optimisation and fault analysis can thus be carried out easily via a laptop computer.

Speed control (WG 30 and WG 40)

Whereas normally a burner motor is operated at a constant speed, speed controlled burners vary the speed of the burner motor dependent on the burner load. The process is controlled by the digital combustion manager. The equipment assures the gas/air compound such that no additional speed monitoring is required.

Speed controls offers the advantages of reduced electrical consumption and a considerable reduction in noise levels at partial load.

The reduced noise levels can be of particular benefit in the field. A 10 dB reduction in the sound level can be achieved at 50% burner load, which equates to a halving of noise emissions.

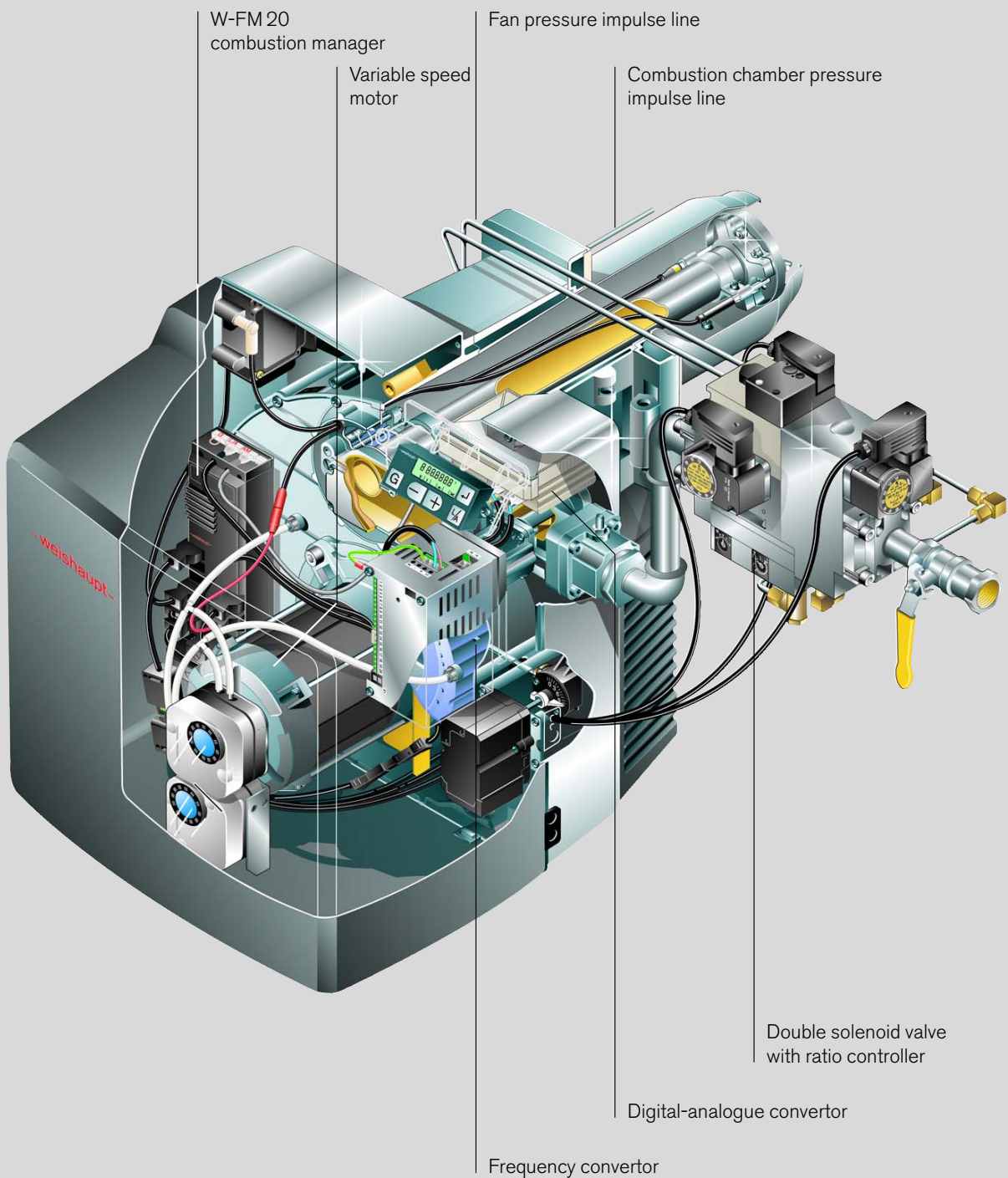

Example: WG40 with speed control

Model overview

Burner type	Version	Mode of operation	Valve train BSP / DN	Rating kW	Product Ident-Number	Order No.
WG 10						
Natural gas						
WG 10 N/0-D	ZM-LN	sliding two stage or modulating	1/2" ③	12,5 – 50	CE-0085 AU 353	232 136 14
WG 10 N/1-D	LN	single stage with manually set air damper	3/4"	40 – 110	CE-0085 BM 0481	232 110 24
WG 10 N/1-D	Z-LN	single or two stage	3/4"	25 – 110	CE-0085 BM 0481	232 123 24
WG 10 N/1-D	ZM-LN	sliding two stage or modulating	3/4"	25 – 110	CE-0085 BM 0481	232 126 24
LPG						
WG 10 F/0-D	ZM-LN	sliding two stage or modulating	1/2" ③	12,5 – 50	CE-0085 AU 353	233 136 14
WG 10 F/1-D	LN	single stage with manually set air damper	3/4"	40 – 110	CE-0085 BM 0481	233 110 24
WG 10 F/1-D	Z-LN	single or two stage	3/4"	25 – 110	CE-0085 BM 0481	233 113 24
WG 10 F/1-D	ZM-LN	sliding two stage or modulating	3/4"	25 – 110	CE-0085 BM 0481	233 126 24
WG 20						
Natural Gas						
WG 20 N/1-C	LN	single stage with manually set air damper	1" ①	80 – 200	CE-0085 BM 0216	232 210 34
WG 20 N/1-C	Z-LN	single or two stage	1" ①	35 – 200	CE-0085 BM 0216	232 213 34
WG 20 N/1-C	ZM-LN	sliding two stage or modulating	1" ①	35 – 200	CE-0085 BM 0216	232 216 34
WG 20 N/1-C	LN	single stage with manually set air damper	1" ②	80 – 200	CE-0085 BM 0216	232 210 44
WG 20 N/1-C	Z-LN	single or two stage	1" ②	35 – 200	CE-0085 BM 0216	232 213 44
WG 20 N/1-C	ZM-LN	sliding two stage or modulating	1" ②	35 – 200	CE-0085 BM 0216	232 216 44
LPG						
WG 20 F/1-C	LN	single stage with manually set air damper	3/4" ①	80 – 200	CE-0085 BM 0216	233 210 24
WG 20 F/1-C	Z-LN	single or two stage	3/4" ①	35 – 200	CE-0085 BM 0216	233 213 24
WG 20 F/1-C	ZM-LN	sliding two stage or modulating	3/4" ①	35 – 200	CE-0085 BM 0216	233 216 24
WG 30						
WG 30N/1-C	ZM-LN	sliding two stage or modulating	3/4" 1" 1 1/2"	40 – 350	CE-0085-AU 0064	232 326 21 232 326 31 232 326 51
WG 30F/1-C	ZM-LN	sliding two stage or modulating	3/4"	60 – 350	CE-0085-AU 0064	233 326 21
WG 40						
WG 40N/1-A	ZM-LN	sliding two stage or modulating	3/4" 1" 1 1/2" 2" DN65 DN80	55 – 550	CE-0085-AS 0311	232 416 21 232 426 31 232 416 51 232 406 61 232 416 31 232 416 41
WG 40F/1-A	ZM-LN	sliding two stage or modulating	3/4"	80 – 550	CE-0085-AS 0311	233 416 21
<p>① with gas multifunction assembly type 507 ② with gas multifunction assembly type 512 ③ for supply pressure $p_a \leq 50$ mbar only ($p_a > 50$ mbar to 300 mbar at extra cost)</p> <p>Note: Valve trains are supplied without thermal shut offs.</p> <p>See Weishaupt accessories list for thermal shut off prices, Print No. 83021201.</p>						
See price list for special equipment						

Burner capacities in relation to combustion chamber resistance

Capacity graph WG 10

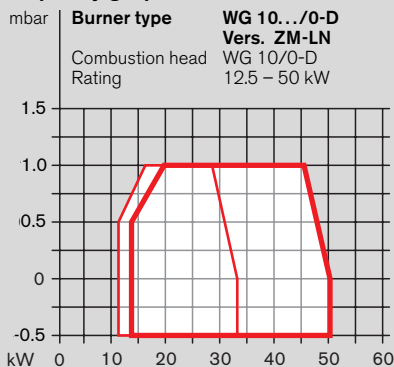

Capacity graph WG 10

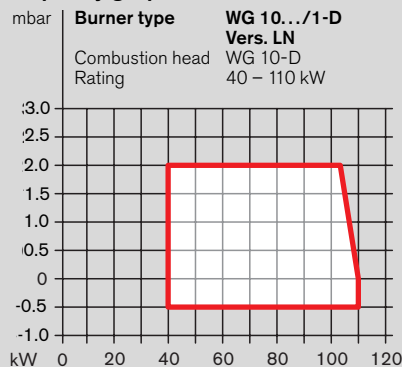

Capacity graph WG 10

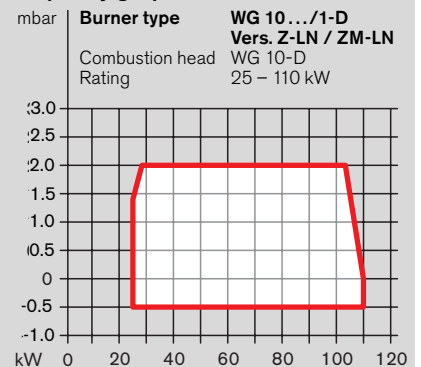

Capacity graph WG 20

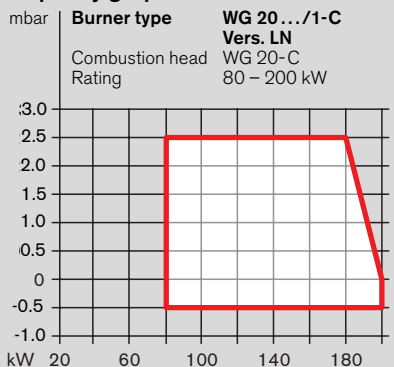

Capacity graph WG 20

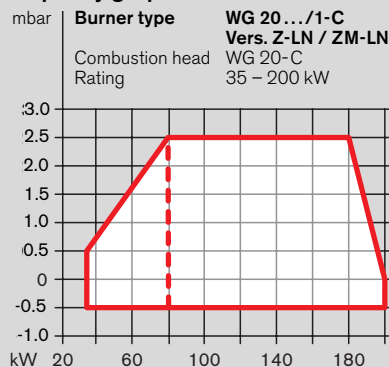

Capacity graph WG 30

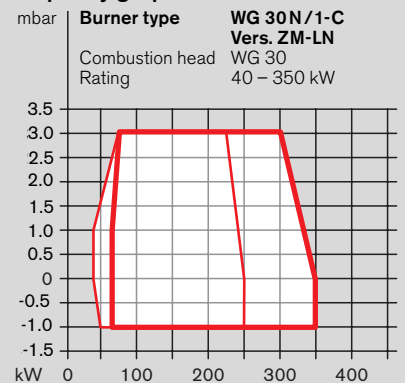

Capacity graph WG 30

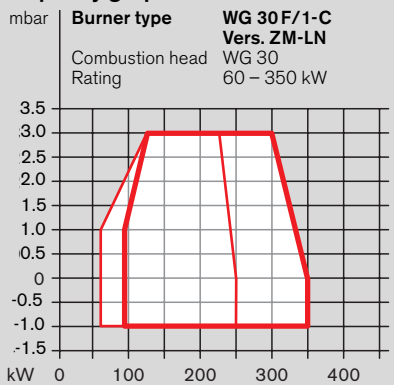

Capacity graph WG 40

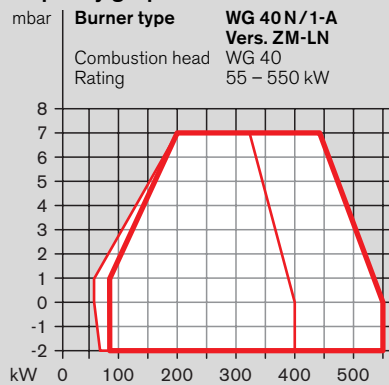

Capacity graph WG 40

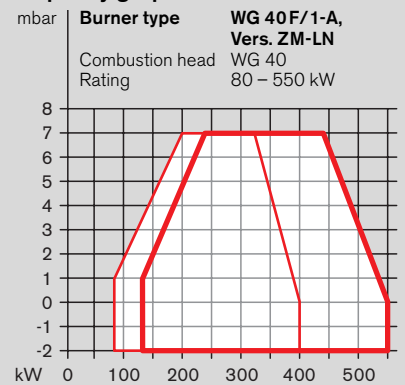

Mixing head "open" — Mixing head "closed" —

Capacity graphs in accordance with EN 676. The ratings are based on an installation altitude of 0 m. An altitude-based reduction in capacity of approx. 1 % per 100 m above sea level should be taken into consideration.

Speed control is available for natural gas burners only. The minimum rating is limited to 60 kW for WG30 and 80 kW for WG 40 burners.

Valve train selection

WG 10.../0-D with W-MF 055

Burner rating	Low pressure supply (Supply pressure in mbar into isolating valve)	
	$p_{e,max} \leq 50$ mbar	$p_{e,max} > 50, \leq 300$ mbar
[kW]	1/2' ③	1/2' ③
Nat. gas E, $H_i = 37.26$ MJ/m$_n^3$ (10.35 kWh/m$_n^3$), $d = 0.606$, $W_i = 47.84$ kWh/m$_n^3$		
25	15	18
30	15	18
35	16	19
40	16	19
45	17	20
50	18	21

Burner rating	Low pressure supply (Supply pressure in mbar into isolating valve)	
	$p_{e,max} \leq 50$ mbar	$p_{e,max} > 50, \leq 300$ mbar
[kW]	1/2'	1/2' ③
Nat. gas LL, $H_i = 31.79$ MJ/m$_n^3$ (8.83 kWh/m$_n^3$), $d = 0.641$, $W_i = 39.67$ kWh/m$_n^3$		
25	15	18
30	16	19
35	17	20
40	18	21
45	19	22
50	20	23

Burner rating	Low pressure supply (Supply pressure in mbar into isolating valve)	
	$p_{e,max} \leq 50$ mbar	$p_{e,max} > 50, \leq 300$ mbar
[kW]	1/2'	1/2' ③
LPG B/P, $H_i = 93.20$ MJ/m$_n^3$ (25.89 kWh/m$_n^3$), $d = 1.555$, $W_i = 74.73$ kWh/m$_n^3$		
25	13	16
30	13	16
35	13	16
40	14	17
45	14	17
50	15	18

WG 10.../1-D with W-MF 507 SE / SLE

Burner rating	Low pressure supply (Supply pressure in mbar into isolating valve)	
	$p_{e,max} = 300$ mbar	
[kW]	3/4'	
Nat. gas E, $H_i = 37.26$ MJ/m$_n^3$ (10.35 kWh/m$_n^3$), $d = 0.606$, $W_i = 47.84$ kWh/m$_n^3$		
40	10	
50	10	
60	10	
70	10	
80	10	
90	11	
100	12	
110	13	

Burner rating	Low pressure supply (Supply pressure in mbar into isolating valve)	
	$p_{e,max} = 300$ mbar	
[kW]	3/4'	
Nat. gas LL, $H_i = 31.79$ MJ/m$_n^3$ (8.83 kWh/m$_n^3$), $d = 0.641$, $W_i = 39.67$ kWh/m$_n^3$		
40	12	
50	12	
60	12	
70	12	
80	13	
90	14	
100	15	
110	16	

Burner rating	Low pressure supply (Supply pressure in mbar into isolating valve)	
	$p_{e,max} = 300$ mbar	
[kW]	3/4'	
LPG B/P, $H_i = 93.20$ MJ/m$_n^3$ (25.89 kWh/m$_n^3$), $d = 1.555$, $W_i = 74.73$ kWh/m$_n^3$		
40	8	
50	8	
60	9	
70	9	
80	10	
90	11	
100	12	
110	12	

WG 20.../1-C with W-MF 5xx SE / SLE

Burner rating	Low pressure supply (Supply pressure in mbar into isolating valve)	
	$p_{e,max} = 300$ mbar	
[kW]	1" ①	1" ②
Nat. gas E, $H_i = 37.26$ MJ/m$_n^3$ (10.35 kWh/m$_n^3$), $d = 0.606$, $W_i = 47.84$ kWh/m$_n^3$		
80	13	11
90	13	11
100	13	11
110	14	12
120	14	13
130	15	13
140	15	13
150	16	14
160	16	15
170	16	15
180	16	15
190	17	16
200	18	16

Burner rating	Low pressure supply (Supply pressure in mbar into isolating valve)	
	$p_{e,max} = 300$ mbar	
[kW]	1" ①	1" ②
Nat. gas LL, $H_i = 31.79$ MJ/m$_n^3$ (8.83 kWh/m$_n^3$), $d = 0.641$, $W_i = 39.67$ kWh/m$_n^3$		
80	15	13
90	15	13
100	15	14
110	16	14
120	16	15
130	17	16
140	18	16
150	18	17
160	19	17
170	20	18
180	21	18
190	22	19
200	23	20

Burner rating	Low pressure supply (Supply pressure in mbar into isolating valve)	
	$p_{e,max} = 300$ mbar	
[kW]	3/4'	
LPG B/P, $H_i = 93.20$ MJ/m$_n^3$ (25.89 kWh/m$_n^3$), $d = 1.555$, $W_i = 74.73$ kWh/m$_n^3$		
80	13	
90	13	
100	13	
110	14	
120	14	
130	14	
140	14	
150	15	
160	15	
170	16	
180	17	
190	18	
200	19	

- ① with gas multifunction assembly type 507
- ② with gas multifunction assembly type 512
- ③ additional FRS governor required when $p_a > 50$ mbar (to max 300 mbar)

WG 30.../1-C, LN version with W-MF 5xx SE

Burner rating	Low pressure supply (Supply pressure in mbar into isolating valve) $p_{e,max} = 300$ mbar		
[kW]	3/4"	1"	1 1/2"
Nat. gas E, $H_i = 37.26$ MJ/m³ (10.35 kWh/m³), $d = 0.606$, $W_i = 47.84$ kWh/m³			
130	15	14	13
160	17	15	14
190	18	15	13
210	19	15	13
240	21	15	13
270	23	16	13
300	26	17	14
350	33	20	16

Burner rating	Low pressure supply (Supply pressure in mbar into isolating valve) $p_{e,max} = 300$ mbar		
[kW]	3/4"	1"	1 1/2"
Nat. gas LL, $H_i = 31.79$ MJ/m³ (8.83 kWh/m³), $d = 0.641$, $W_i = 39.67$ kWh/m³			
130	18	15	14
160	20	16	15
190	22	17	15
210	23	17	15
240	26	18	15
270	30	19	15
300	34	21	17
350	44	26	21

Burner rating	Low pressure supply (Supply pressure in mbar into isolating valve) $p_{e,max} = 300$ mbar
[kW]	3/4"
LPG B/P, $H_i = 93.20$ MJ/m³ (25.89 kWh/m³), $d = 1.555$, $W_i = 74.73$ kWh/m³	
130	13
160	14
190	14
210	15
240	15
270	17
300	18
350	21

WG 40.../1-A, LN version with W-MF 5xx SE or DMV + FRS

Burner rating	Low pressure supply (Supply pressure in mbar into isolating valve) $p_{e,max} = 300$ mbar					
[kW]	3/4"	1"	1 1/2"	2"	65	80
Nat. gas E, $H_i = 37.26$ MJ/m³ (10.35 kWh/m³), $d = 0.606$, $W_i = 47.84$ kWh/m³						
240	19	14	12	11	11	11
270	22	14	12	12	11	11
300	25	15	13	12	11	11
350	30	17	13	13	12	11
400	36	19	14	13	12	11
450	42	22	15	14	12	12
500	52	27	18	17	15	14
550	61	31	21	19	16	15

Burner rating	Low pressure supply (Supply pressure in mbar into isolating valve) $p_{e,max} = 300$ mbar					
[kW]	3/4"	1"	1 1/2"	2"	65	80
Nat. gas LL, $H_i = 31.79$ MJ/m³ (8.83 kWh/m³), $d = 0.641$, $W_i = 39.67$ kWh/m³						
240	26	17	15	14	13	13
270	29	18	15	14	13	13
300	33	19	15	14	13	13
350	40	22	16	15	13	13
400	49	26	18	17	15	14
450	60	30	21	19	16	15
500	72	35	23	21	18	17
550	86	42	27	25	21	19

Burner rating	Low pressure supply (Supply pressure in mbar into isolating valve) $p_{e,max} = 300$ mbar
[kW]	3/4"
LPG B/P, $H_i = 93.20$ MJ/m³ (25.89 kWh/m³), $d = 1.555$, $W_i = 74.73$ kWh/m³	
240	13
270	14
300	16
350	19
400	22
450	26
500	29
550	33

WG 30.../1-C with DMV-VEF (speed controlled burner)

Burner rating	Low pressure supply (Supply pressure in mbar into isolating valve) $p_{e,max} = 300$ mbar			
[kW]	3/4"	1"	1 1/2"	2"
Nat. gas E, $H_i = 37.26$ MJ/m³ (10.35 kWh/m³), $d = 0.606$, $W_i = 47.84$ kWh/m³				
130	18	6	6	5
160	21	9	8	7
190	25	12	10	10
220	29	15	13	12
250	32	18	15	14
280	37	24	16	14
310	43	28	17	16
350	51	33	19	18

Burner rating	Low pressure supply (Supply pressure in mbar into isolating valve) $p_{e,max} = 300$ mbar			
[kW]	3/4"	1"	1 1/2"	2"
Nat. gas LL, $H_i = 31.79$ MJ/m³ (8.83 kWh/m³), $d = 0.641$, $W_i = 39.67$ kWh/m³				
130	23	8	7	6
160	28	11	9	9
190	34	14	12	11
220	40	17	15	14
250	46	20	17	16
280	52	26	19	17
310	61	32	20	19
350	73	40	23	21

Clarification of designation

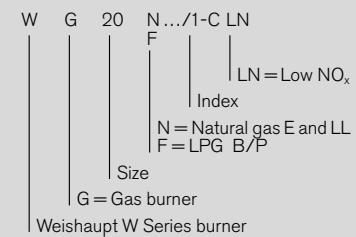

WG 40.../1-A with DMV-VEF (speed controlled burner)

Burner rating	Low pressure supply (Supply pressure in mbar into isolating valve) $p_{e,max} = 300$ mbar			
[kW]	3/4"	1"	1 1/2"	2"
Nat. gas E, $H_i = 37.26$ MJ/m³ (10.35 kWh/m³), $d = 0.606$, $W_i = 47.84$ kWh/m³				
240	30	11	10	9
300	40	14	13	11
360	54	18	15	13
400	64	20	17	15
440	75	23	20	16
480	88	26	24	18
520	101	29	28	20
550	111	31	30	22

Burner rating	Low pressure supply (Supply pressure in mbar into isolating valve) $p_{e,max} = 300$ mbar			
[kW]	3/4"	1"	1 1/2"	2"
Nat. gas LL, $H_i = 31.79$ MJ/m³ (8.83 kWh/m³), $d = 0.641$, $W_i = 39.67$ kWh/m³				
240	42	13	11	10
300	57	18	15	13
360	74	22	19	16
400	92	25	22	18
440	109	29	24	20
480	126	34	28	22
520	144	36	34	25
550	157	38	37	27

Notes:

1/2" to 2" valve trains have screwed connections, DN65 and DN80 have flanged connections.

The valve trains can be equipped with thermal shut offs at extra cost.

The flue gas resistance must be added to the minimum supply pressure calculated.

The minimum supply pressure should be no less than 15 mbar.

Technical data

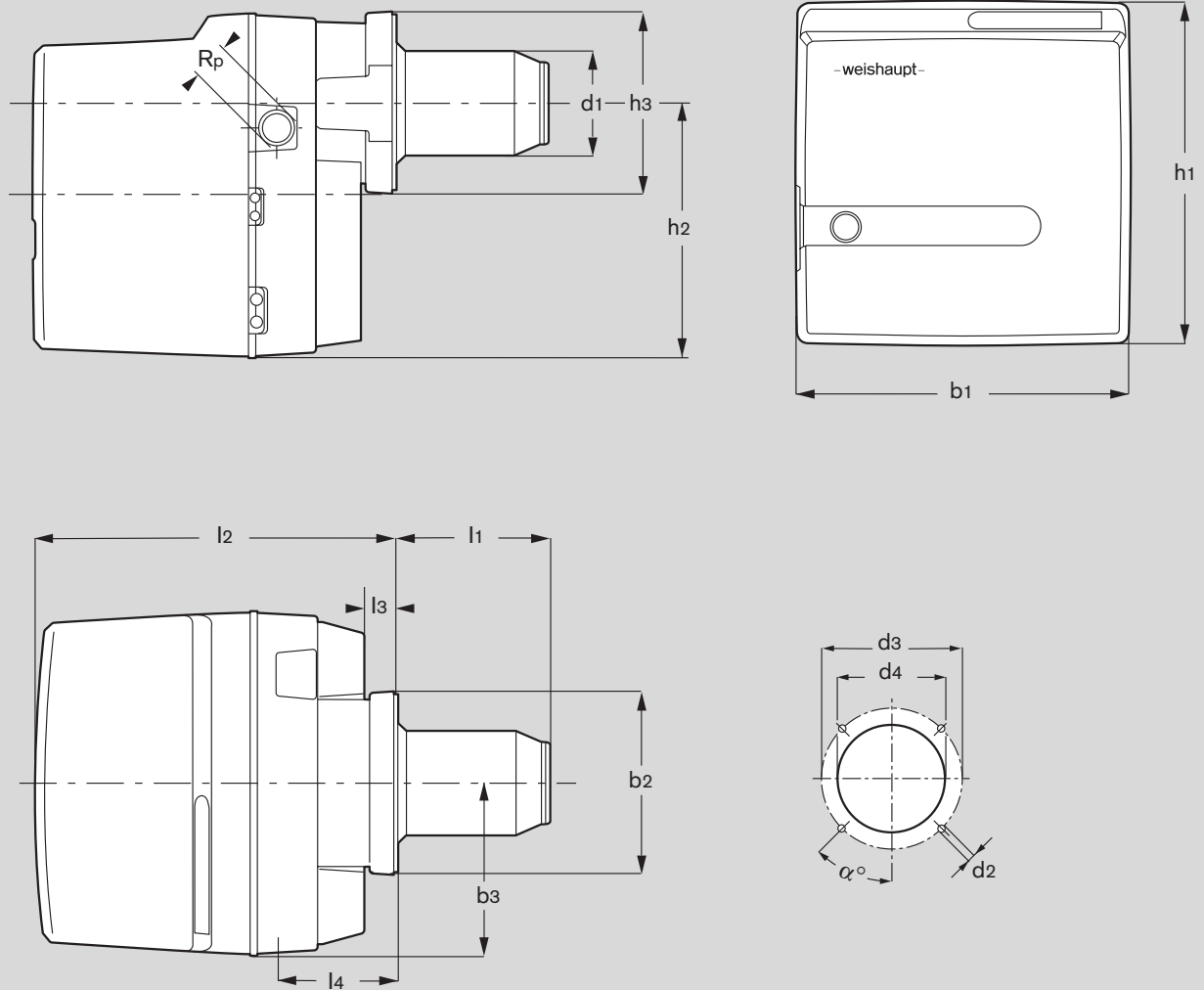

Burner dimensions

Burner type	Dimensions in mm																
	l ₁	l ₂	l ₃	l ₄	b ₁	b ₂	b ₃	h ₁	h ₂	h ₃	d ₁	d ₂	d ₃	d ₄	Rp	α°	
WG 10	140	349	31,5	115	330	165	164	353	270	165	108	M8	150-170	110	3/4"	45°	
WG 20	140	397	32	158	358	182	178	376	284,5	182	120	M8	170	130	1"	45°	
WG 30	166	480	62	197	420	226	196	460	342	226	127	M8	170-186	130	1 1/2"	45°	
WG 40	235	577	72	235	450	245	207	480	360	245	154	M10	186-200	160	1 1/2"	45°	

Technical data									
Burner type	Combust. manager	Motor	Servomotor	Air pressure switch	Burner weight ①	Gas valve train		Weight ①	Flame monitoring
						Size	Type		
WG 10.../0-D									
Vers. ZM-LN	W-FM 20	ECK 02/F – 2/1 230 V, 50 Hz 0.04 kW, Cap. 2 µF	STE 4.5 *	LGW 3/A1	13.5 kg	1/2"	W-MF 055	6 kg	Ionisation
WG 10.../1-D									
Vers. LN	W-FM 05	ECK 03/F – 2/1	none	LGW 10/A2	13.5 kg	3/4"	W-MF SLE 507	6 kg	Ionisation
Vers. Z-LN	W-FM 10	230 V, 50 Hz	STD 4.5 **			3/4"	W-MF SE 507		
Vers. ZM-LN	W-FM 20	0.095 kW, Cap. 4 µF	STE 4.5 *			3/4"	W-MF SE 507		
WG 20.../1-C									
Vers. LN	W-FM 05	ECK 04/F – 2/1	none	LGW 10/A2	20 kg	1"	W-MF SLE 507/512	6 kg / 7 kg	Ionisation
Vers. Z-LN	W-FM 10	230 V, 50 Hz	STD 4.5 **			1"	W-MF SE 507/512		
Vers. ZM-LN	W-FM 20	0.21 kW, Cap. 8 µF	STE 4.5 *			1"	W-MF SE 507/512		
WG 30.../1-C									
Vers. ZM-LN	W-FM 20	ECK 05/F-2 230 V; 50 Hz 2900 rpm 0.42 kW; Cap. 12 µF	STE 4.5 * BO.36/6-01L	LGW 10A2	27 kg	3/4" 1" 1 1/2"	W-MF SE 507 W-MF SE 512 W-MF SE 512	5.5 kg 9.0 kg 13.5 kg	Ionisation
Vers. ZM-LN with speed control	W-FM 20	DK 05/F-2 3~; 230 V; 50 Hz 2880 rpm 0.42 kW; 2.6 A	STE 4.5 * BO.36/6-01L	LGW 10A2	30 kg	3/4" 1" 1 1/2" 2"	DMV-VEF 507 DMV-VEF 512 DMV-VEF 512 DMV-VEF 520	6.5 kg 10.0 kg 12.0 kg 15.0 kg	Ionisation
WG 40.../1-A									
Vers. ZM-LN	W-FM 20	ECK 06/F-2 230 V; 50 Hz 2900 rpm 0.62 kW; Cap. 16 µF	STE 4.5 * BO.36/6-01L	LGW 10A2	35 kg	3/4" 1" 1 1/2" 2" 65 80	W-MF SE 507 W-MF SE 512 W-MF SE 512 DMV+FRS 520 DMV+FRS 5065 DMV+FRS 5080	5.5 kg 9.0 kg 13.5 kg 17.5 kg 50.0 kg 67.0 kg	Ionisation
Ausf. ZM-LN with speed control	W-FM 20	DK 06/F-2 3~; 230 V; 50 Hz 2900 rpm 0.62 kW; 4 A	STE 4.5 * BO.36/6-01L	LGW 10A2	38 kg	1" 1 1/2" 2"	DMV-VEF 512 DMV-VEF 512 DMV-VEF 520	10.0 kg 12.0 kg 15.0 kg	Ionisation

* Runtime during operation: with full setting movement max. 50 s/with reduced setting movement min. 25 s/ Runtime during pre-purge approx. 1–2 s.

** Runtime during operation: with full setting movement approx. 3 s/with reduced setting movement < 3 s/ Runtime during pre-purge approx. 3 s.

① All weights are approximate.

- weishaupt -

Max Weishaupt GmbH
D-88475 Schwendi
Tel (073 53) 8 30, Fax (073 53) 8 33 58
www.weishaupt.de

Print No. 83205502, April 2006
Printed in Germany. All rights reserved.

Neachells Lane, Willenhall, WV13 3RG
Tel (01902) 609841, Fax (01902) 633343

63 Carlton Place, Glasgow, G5 9TW
Tel (0141) 420 2030, Fax (0141) 420 2088

We're right where you need us

A strong service network gives peace of mind

Weishaupt equipment is available from good heating companies, with whom Weishaupt works in partnership. To support the specialists, Weishaupt maintains a large sales and service network. Delivery, spares and service are thus continually ensured.

Even in an emergency, Weishaupt is on the job. The service department is available to Weishaupt customers around the clock, 365 days a year. A Weishaupt branch office or agency near you can answer all your questions on heating and Weishaupt burners and heating systems.

